

The V5 Inspection Planner

**LEVERAGE THE POWER OF CATIA V5
FOR INSPECTION PLANNING & PROGRAMMING.**

The V5 Inspection Planner

HIGH LEVEL OVERVIEW & FEATURES

- Eliminates translation from CATIA-based inspection planning.
- Supports aerospace MBD processes & best-practices
- Improves programming efficiency
- Eliminates error
- Easy to learn
- Proven & Flexible post processor

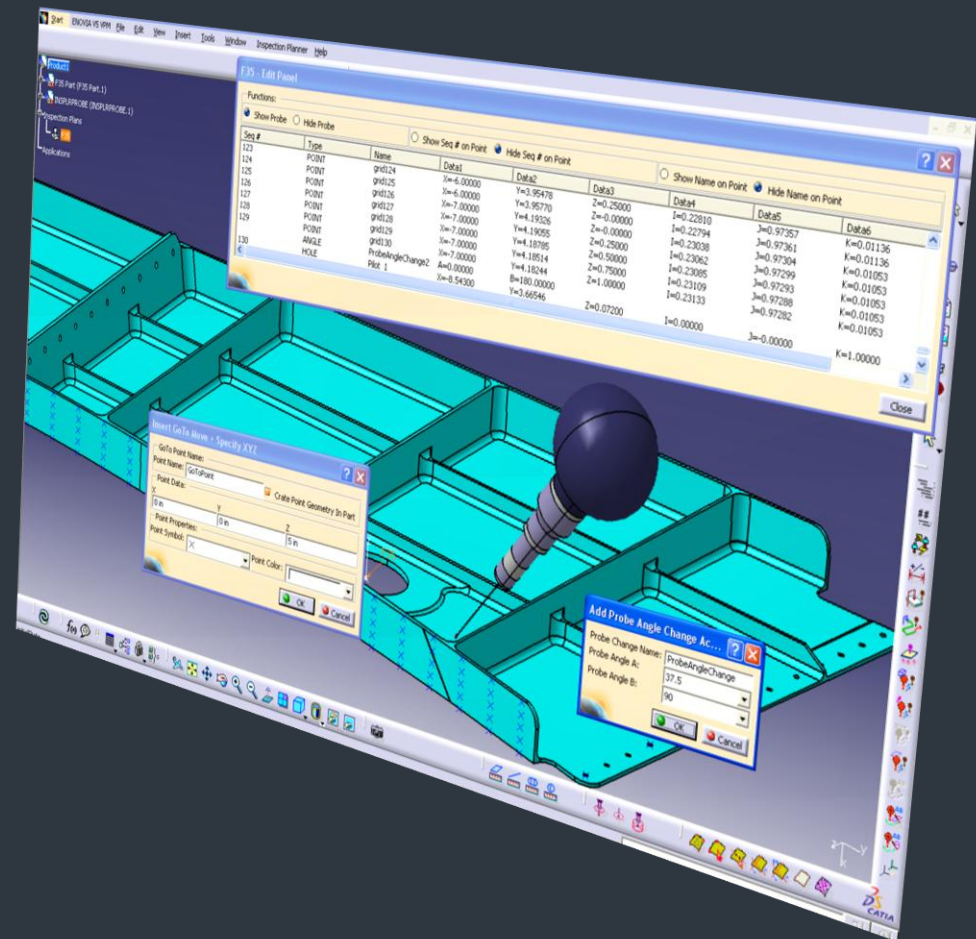

3D Labeling for Inspection Road Maps

VALUES:

Supports Model Based Definition requirement for graphical road maps.

Provides graphical representation to correlate to text based reports.

Supports unique naming of points to support MBD Best Practices.

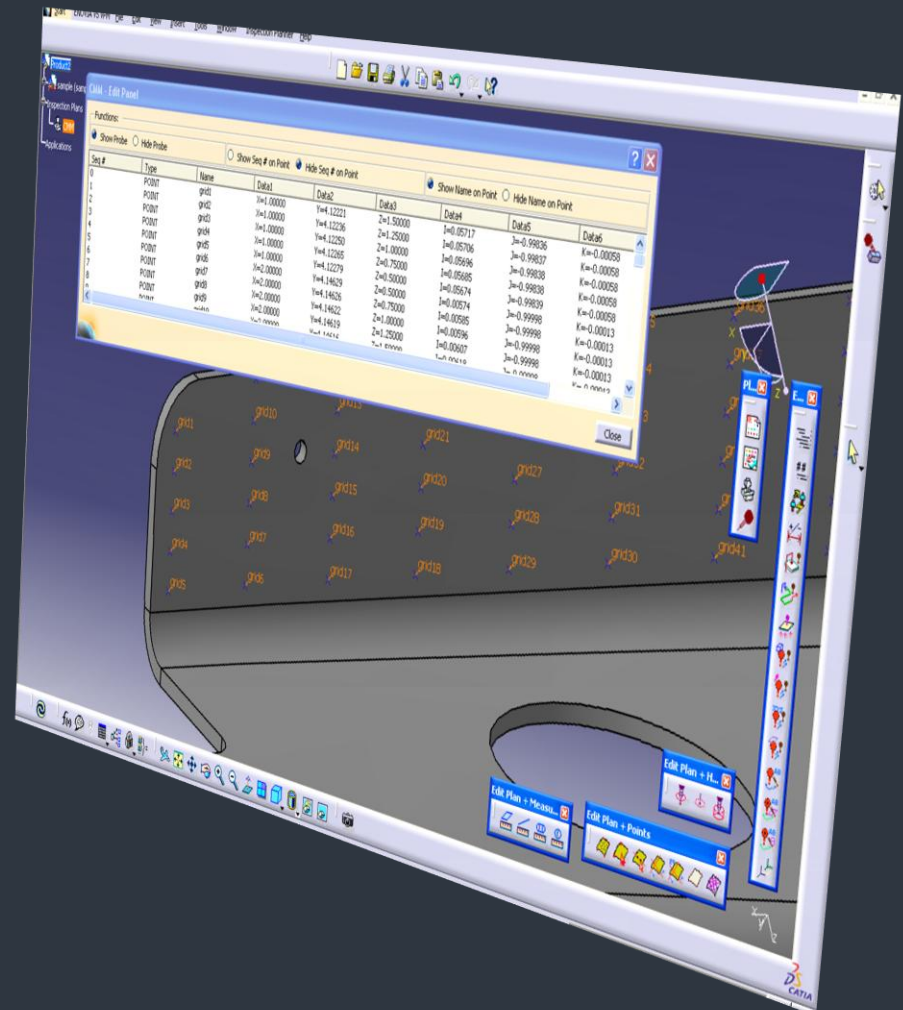

CMM Programming in context of the 3D CATIA V5 assembly (.catproduct)

VALUES

Program with NC / holding fixtures in mind.

Avoid collisions.

Speed up programming.

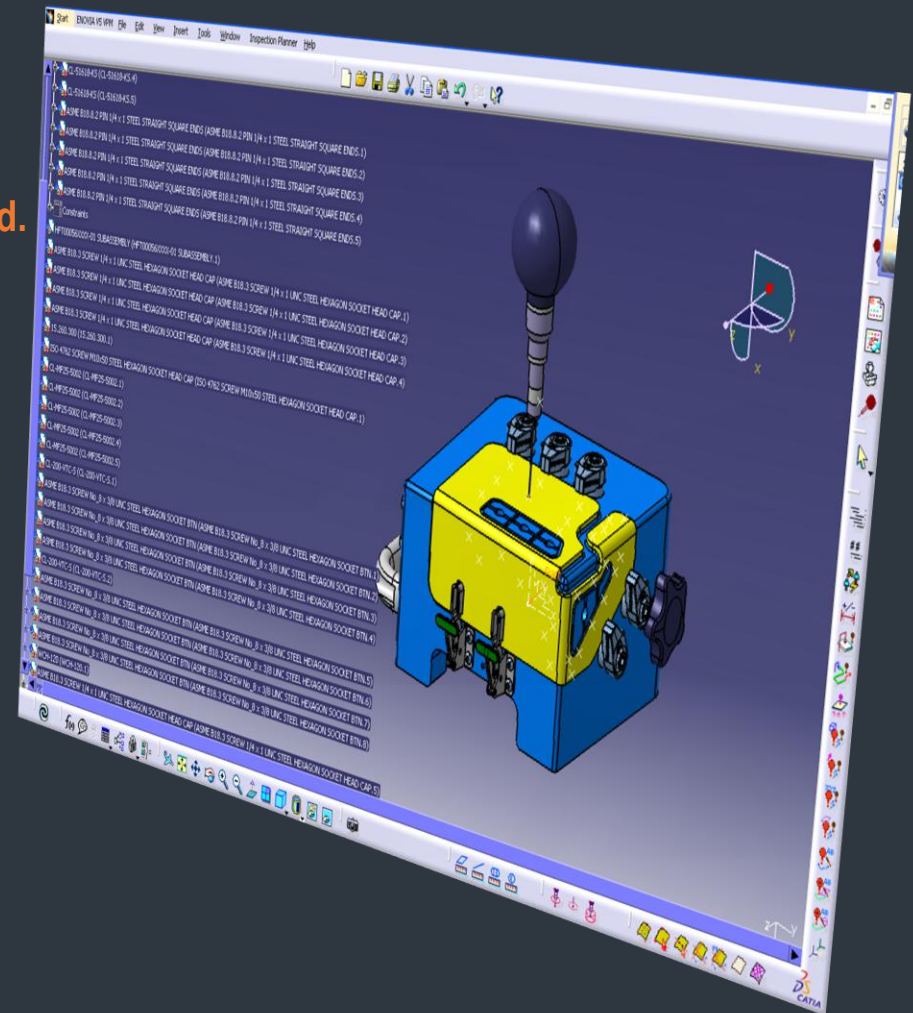

APT-source playback / simulation

VALUE

Replay the inspection plan in an NC Process

Prove out inspection plan in 3rd Party NC Simulation tools . (Vericut)

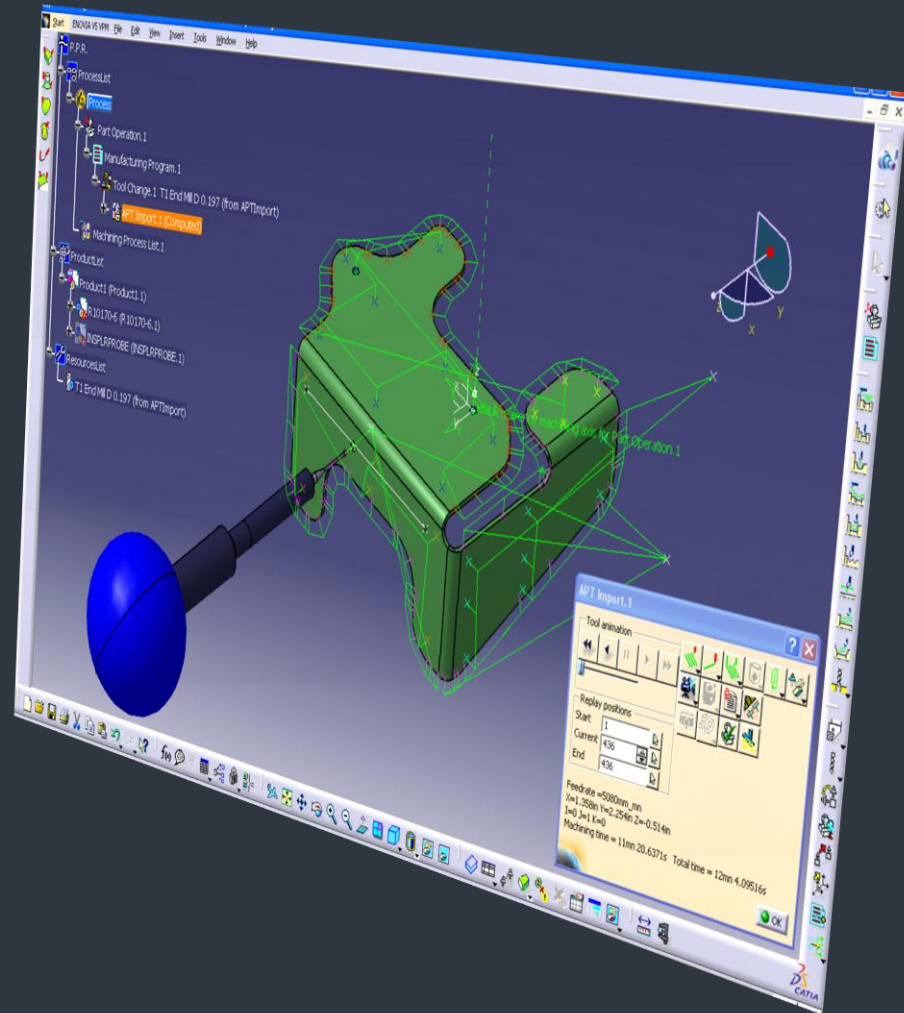

Fully Integrated Programming Workbenches

VALUES

Common V5 look & feel

Easy to learn

Made for programmers

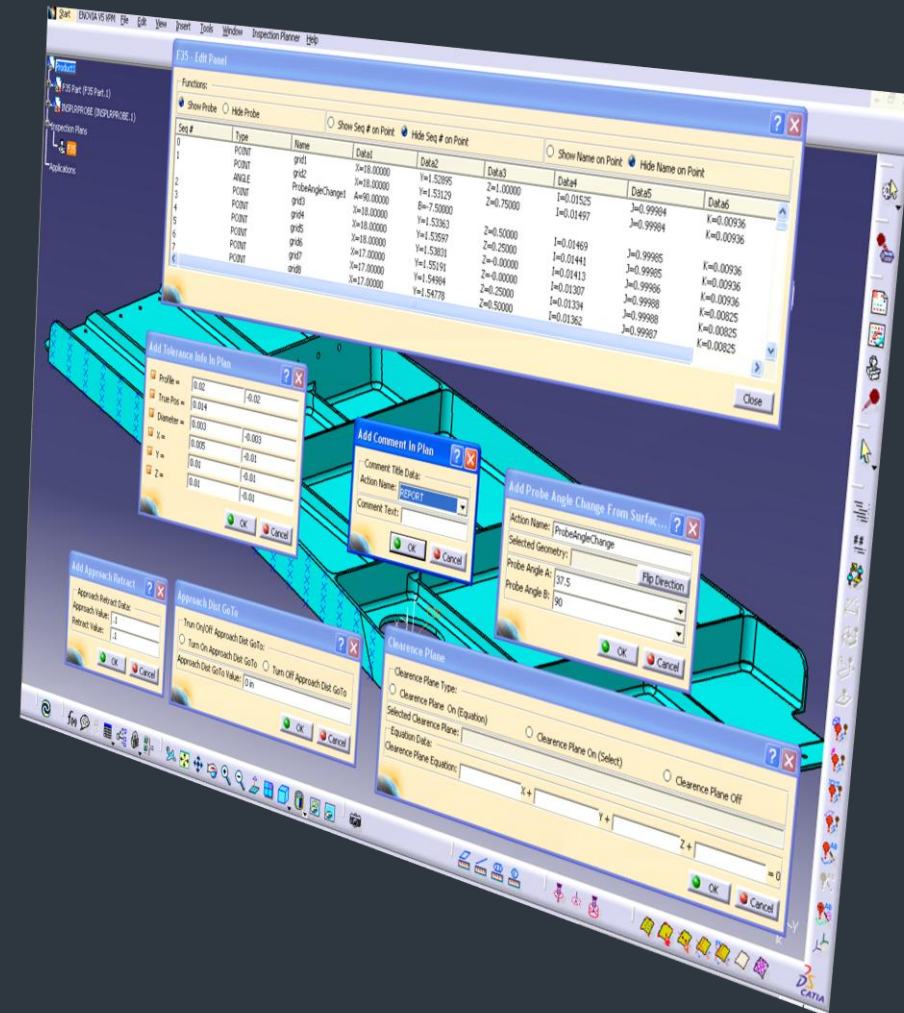

Grid of Points on Complex Surfaces

VALUE

Rapid programming of complex parts

Supports multiple programming strategies of creation points on complex parts.

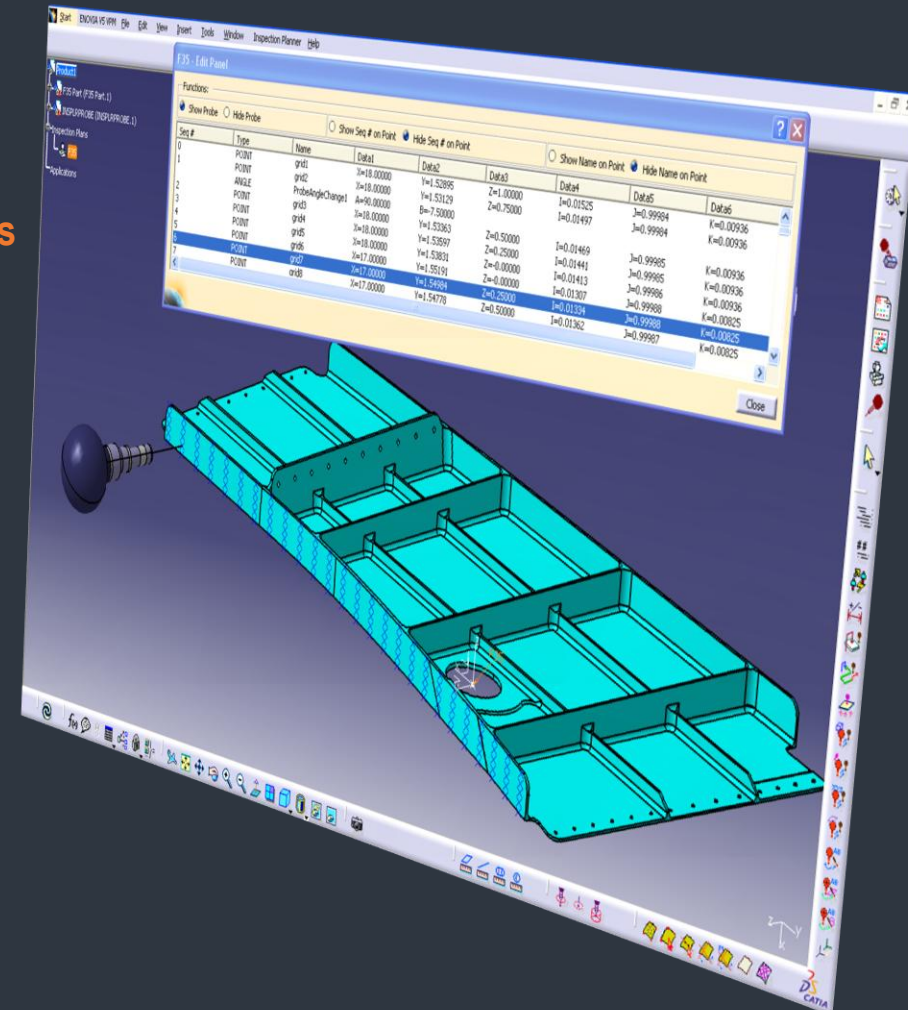

Rapid Hole Inspection

VALUE

Variety of Hole Programming strategies

5-axis

2D Holes

Pilot / Point-Vector Holes

“One-Click” hole programming

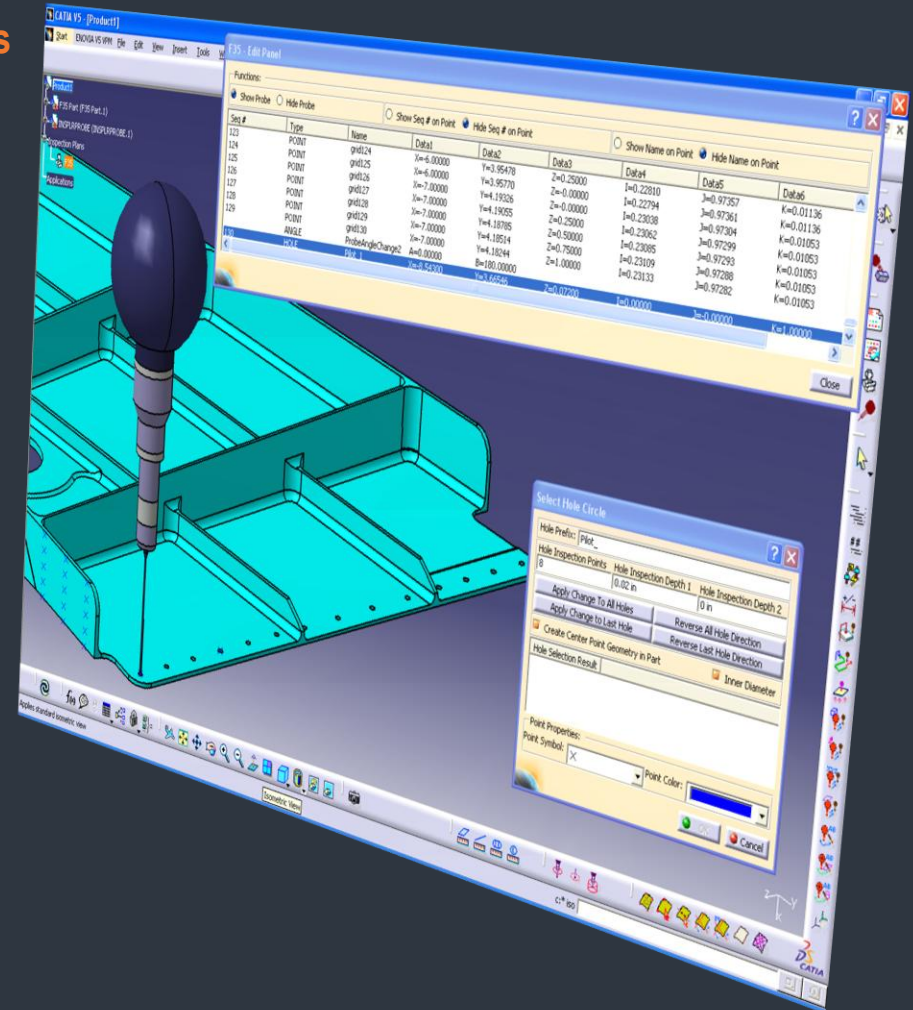

Integrated Probe Builder

SUBTITLE CONTENT PAGE WITH TEXT AND PHOTO

Probe Builder

Quick and Easy creation multiple probes

SUB HEADING THREE

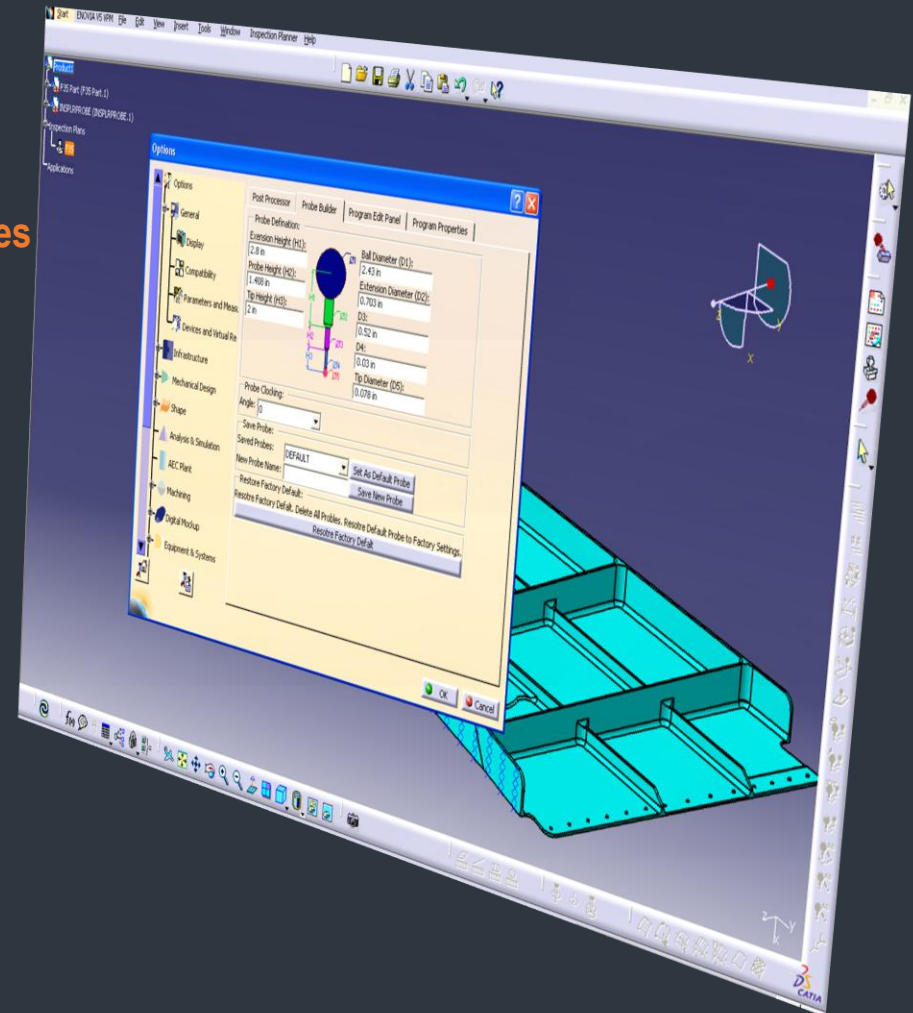

Integrated Post-Processor

VALUE

Integrated Post-Processor provides great flexibility by posting to multiple languages:

PC DIMS

Virtual DIMS

CAMIO / LK DIMS

GeoDIMS

OpenDIMS

Capps/Edges DIMS

GeoPAK

TUTOR for Windows

Ziess

G-Code

APT Source

QAID

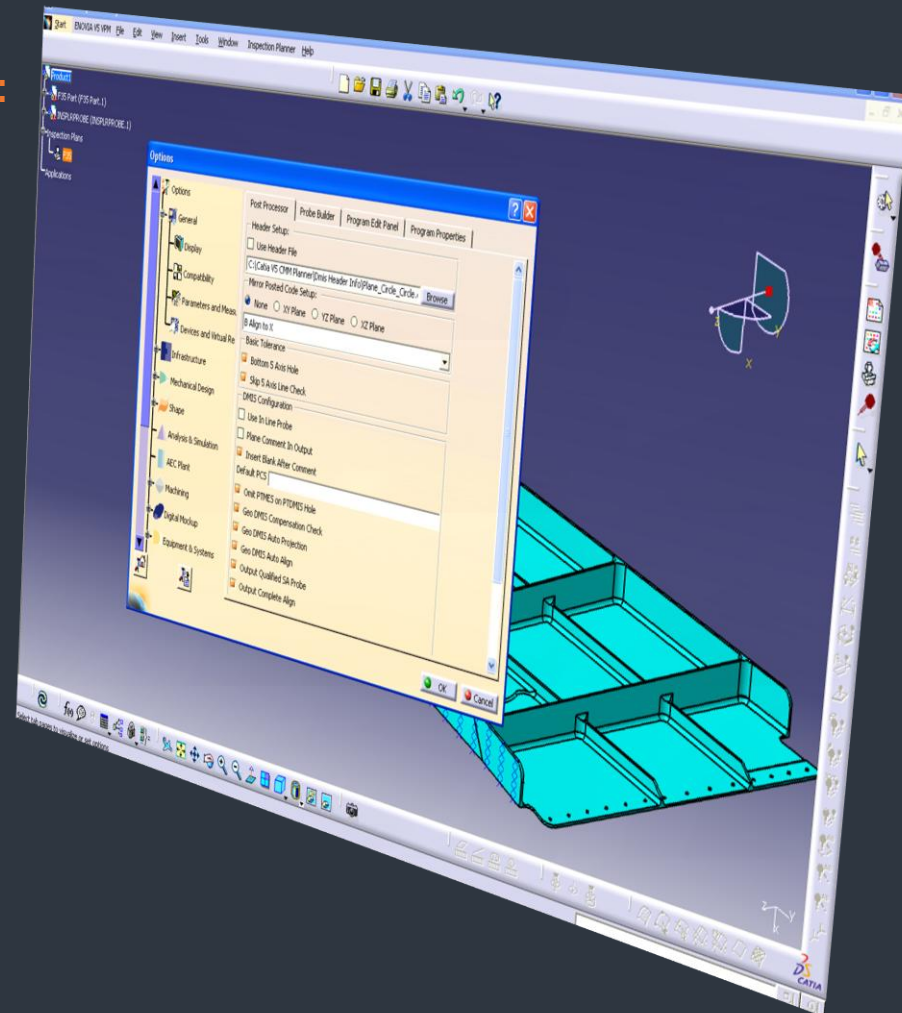

FOR MORE INFORMATION CONTACT:

Larry Kuehn

Western Regional Manager

Adaptive Corporation

4521 Campus Drive, Suite #245 | Irvine | CA | 92612 | USA

Office: (949) 270-2640 | Cell: (949) 633-0850

email: lkuehn@adaptivecorp.com

visit: www.adaptivecorp.com

***Adaptive Corporation - Awarded Dassault Systemes'
Business Partner of the Year***

